

JT421E LTE Module Datasheet

Support band42/43



深圳市简信通科技有限公司
Jaton Technology Co.,Ltd

Notes:

The information in this document is subject to change without notice. Every effort has been made in the preparation of this document to ensure accuracy of the contents, but all statements, information, and recommendations in this document do not constitute the warranty of any kind, express or implied.

INDEX

1 Overview	3
1.1 Overview.....	3
1.2 JT421E LTE Module Appearance.....	3
1.3 JT421E LTE Module Function.....	3
1.4 Acronym.....	5
2 Interfaces	6
2.1 Overview.....	6
2.2 General Mini PCI Express Interface	6
2.2.1 Interface Signals	6
2.2 Antenna Interface	8
2.3.1 Antenna Interface Connector.....	8
2.3.2 RF Performance on Antenna Interface.....	10
3 Interface Electrical Characteristics	11
3.1 Overview.....	11
3.2 Absolute Maximum Ratings.....	11
3.3 Operating and Storage Temperatures.....	12
3.4 Module IO Port Electrical Requirements.....	12
3.5 Power Supply and Consumption.....	12
3.5.1 Input Power	12
3.5.2 Power Consumption	13
3.5.3 Boot Procedure.....	13
3.6 Reliability	14
3.7 ESD.....	15
3.7.1 Overview.....	15
3.7.2 USIM Card Interface ESD Protection	15
4 Interface Applications	16
4.1 Overview.....	16
4.2 USIM Card Interface.....	16
4.3 Power Interface.....	18
4.4 USB Bus	18
4.5 LED Status Indicators.....	18
4.6 RESET Interface.....	19
5 Mechanical Specifications	20
5.1 Overview.....	20
5.2 JT421E Overall Dimensions.....	20
5.3 Mini PCI Express Overall Dimensions.....	22

- LTE comply to 3 GPP Release9 CAT4 standards;
Wimax comply to IEEE 802.16e-2005 wave2 standards;
- LTE supports Band42, Band43 frequency bands;
Wimax supports 3.4 G ~ 3.8GHz;
- LTE supports channel bandwidth of 5M/10M/15M/20M;
Wimax supports channel bandwidth of 5M/7M/10M
- LTE supports eMBMS function;
- Provide general Mini PCI Express interface, interface signals include:
 - Power supply
 - 1 USIM card signal (Support 3.0v or 1.8v)
 - 1 high speed USB2.0 interface
 - Indicator signals, etc.
- Provide main and auxiliary antenna interfaces;
- Support standard AT instruction set;
- Meet ROHS environmental requirements;

Table 1-1 JT421E LTE module key features

Feature	Description
Working Frequency Band	3.4G~3.6GHz, 3.6G~3.8GHz
Maximum Transmit Power	25dBm
Working Temperature	Normal Working Temperature: -20°C ~ +65°C
	Limited Working Temperature: -30°C ~ +70°C
	Storage Temperature: -40°C ~ +85°C
Power Voltage	3.0V ~ 3.6V (Recommend 3.3V)
Consumption (Current)	500mA (Ratio 1:2)
AT Instruction	Support standard AT instruction set
Mini PCI Express Connector	Power
	1 USIM card signal (Support 3.0v or 1.8v)
	1 high speed USB2.0 interface
	Indicator signals
	LTE/Wimax mode switch signal, etc.
External Interface	main and auxiliary antenna interfaces
	general Mini PCI Express interface
Supplementary Service	eMBMS
RoHS Environmental Requirement	Support

1.4 Acronym

Acronym	Full Name
EMC	Electromagnetic Compatibility
ESD	Electrostatic Discharge
FFF	Firmware From Flash
FFH	Firmware From Host
IEC	International Electro technical Commission
IMEI	International Mobile Equipment Identity
I/O	Input/output
ISO	International Standards Organization
ITU	International Telecommunications Union
kbps	kbits per second
LED	Light Emitting Diode
NTC	Negative Temperature Coefficient
PCS	Personal Cellular System
PCI	Peripheral Component Interconnect
PDU	Packet Data Unit
PPP	Point-to-point protocol
PS	Packet Switched
QPSK	Quadrature Phase Shift Keying
TCP/IP	Transmission Control Protocol/ Internet Protocol
UART	Universal asynchronous receiver-transmitter
UIM	User Identified Module
USB	Universal Serial Bus

Figure1-2: Acronym summary

2

Interfaces

2.1 Overview

This chapter mainly introduces the external interfaces of JT421E LTE module, including:

- General Mini PCI Express Interface
- Antenna Interface

2.2 General Mini PCI Express Interface

2.2.1 Interface Signals

The interface of JT421E LTE module is general Mini PCIe interface.

All interface function definitions of 52-pin gold finger in JT421E LTE module are described in Table 2-1.

Table 2-1 Mini PCI Express interface signal definitions

pin	JT421E Signal	I/O	Comment
1	Reserved		
2	VCC3V3	P	
3	UART_TXD	O	UART transmit
4	GND	P	
5	UART_RXD	I	UART receive
6	MII_COL	I	
7	FACT_RST#	I	
8	VSIM	P	USIM card power output
9	GND	P	
10	UIM_DATA	I/O	USIM card data signal
11	MDIO	I/O	
12	UIM_CLK	O	USIM card clock signal

13	MDC	O	
14	UIM_RESET	O	USIM card reset signal
15	GND	P	
16	MII_TCLK	I	
17	MII_RXD0	I	
18	GND	P	
19	MII_RXD1	I	
20	MII_RXER	I	
21	GND	P	
22	PERST#	I	Module reset signal
23	MII_CRS	I	
24	VCC3V3	P	
25	MII_RCLK	I	
26	GND	P	
27	GND	P	
28	MII_TXD2	O	
29	GND	P	
30	MII_RXD3	I	
31	MII_TXD0	O	
32	MII_RXD2	I	
33	MII_TXD1	O	
34	GND	P	
35	GND	P	
36	USB_DM	I/O	USB negative signal
37	GND	P	
38	USB_DP	I/O	USB positive signal
39	VCC3V3	P	
40	GND	P	
41	VCC3V3	P	
42	LED	O	Indicator signal(note 1)
43	GND	P	
44	LED	O	Indicator signal(note 1)
45	MII_RXDV	I	

46	LED	O	Indicator signal(note 1)
47	MII_TXEN	O	
48	MII_TXD3	O	
49	Reserved	O	
50	GND	P	
51	LED	O	Indicator signal(note 1)
52	VCC3V3	P	

Note 1: Reserved GPIO, can be customized, such like indicator signals.

Note 2: In table 2-1, P signifies power supply pin; I signifies digital signal input pin; O signifies digital signal output pin;

2.2 Antenna Interface

2.3.1 Antenna Interface Connector

There are two antenna interfaces in JT421E and LMO38T module respectively used for main and auxiliary antenna. 50ohm cable and antenna must be chosen for antenna resistance. U.FL- R-SMT-1 RF connector made by HRS Company is used for the main and auxiliary antenna interfaces in the module. The size of RF connector is shown in Figure 2-1.

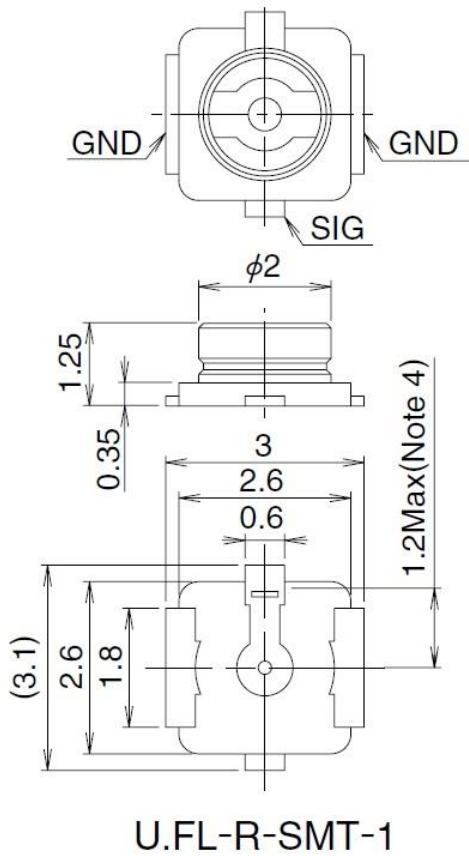

◆ Recommended PCB Mounting Pattern

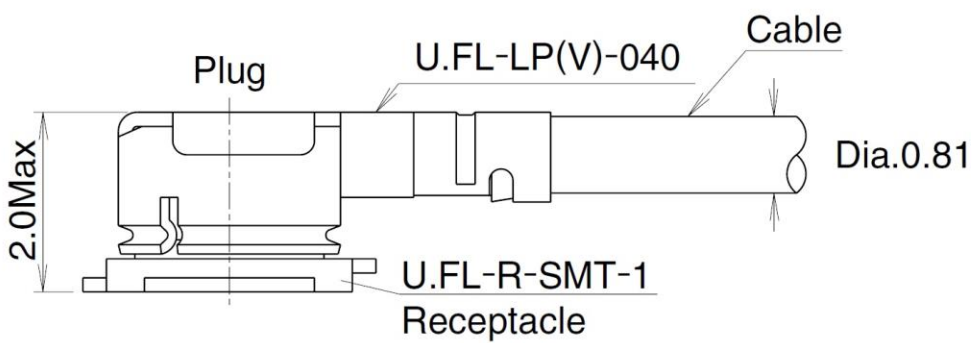
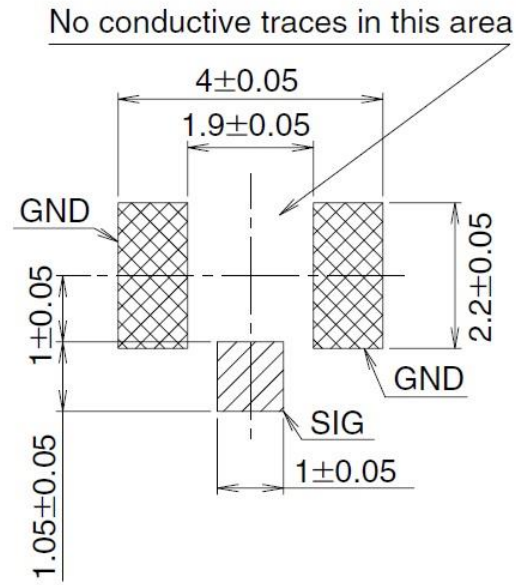

Figure 2-1 RF connector size

2.3.2 RF Performance on Antenna Interface

RF performance on the module antenna interface is shown in Table 2-2.

Table 2-2 RF performance of antenna interface

	Working Frequency Band	Transmit Power (dBm)	Antenna Interface receiving sensitivity
TD-LTE	BAND42 (3400MHz~3600MHz) BAND43 (3600MHz~3800MHz)	23±2	< -96dBm/20MHz

3 Interface Electrical Characteristics

3.1 Overview

This chapter introduces electrical characteristics of JT421E LTE module interfaces, including:

- Limit application conditions
- Operating and storage temperatures
- module IO port level requirements
- Power supply features
- Reliability
- ESD

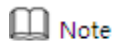

This chapter mainly describes external interfaces' electrical characteristics of JT421E LTE module.

3.2 Absolute Maximum Ratings

JT421E maximum ratings of LTE module is shown in table 3-1. More than these ratings of use for a long time may cause permanent damage to JT421E LTE module.

Table 3-1 JT421E LTE module absolute maximum rating

Parameter	Description	Minimum value	Maximum value	Unit
VCC_3V3	Module Input Voltage	-0.3	6.0	V
V _{IN}	IO Port Input Voltage	-0.3	3.6	V

3.3 Operating and Storage Temperatures

JT421E operating and storage temperature range of the LTE module is shown in table 3-2.

Table 3-2 JT421E LTE module temperature range

Parameter	Parameter Description	Minimum	Maximum	Unit
To	Normal operating temperature	-20	65	°C
Ta	Operating temperature (Reduce RF performance)	-30	70	°C
Ts	Module storage temperature	-40	85	°C

3.4 Module IO Port Electrical Requirements

JT421E recommended application condition of LTE module is shown in table 3-3.

Wherein, $V_{DD_IO} = 3.0V$.

Table 3-3 JT421E recommended application condition

Parameter	Parameter Description	Minimum	Maximum	Unit
VIH	High-level input voltage	2	3.6	V
VIL	Low-level input voltage	-0.3	0.8	V
VOH	output high-level voltage	2.4		V
VOL	output low-level voltage		0.4	V

3.5 Power Supply and Consumption

3.5.1 Input Power

JT421E input power requirements of LTE module are shown in table 3-4.

Table 3-4 JT421E LTE module input power requirements

Parameter	Description	Minimum value	Maximum value	Unit
VCC_3V3	3(TBD)	3.3	3.6	V

3.5.2 Power Consumption

JT421E current requirements of LTE module as shown in table 3-5.

Table 3-5 JT421E LTE module current requirements (Note 2)

Parameter Description	Min	Type	Max	Unit
Power Voltage	3.0	3.3	3.6	V
Connected DRX		20		mA
RRC Idle		4		mA
25dBm (Ratio 1:2)		500		mA

Note 2: Unless specified otherwise, the data in the table are obtained in the following test conditions: VCC_3V3=3.3VDC, T=25°C

3.5.3 Boot Procedure

JT421E LTE module is booted by loading power VCC_3V3;

3.6 Reliability

A part of mechanical reliability test conditions and the results of JT421E LTE module are shown in table 3-6 below:

Table 3-6 Reliability characteristics

Item	Test Condition	Standard
Sinusoidal vibration	Frequency range:5-20Hz; PSD:1.0m ² /s ³ Frequency Range:20-200Hz, -3dB/oct Three axes, each of the axial for 1 hour	IEC 68-2-6
Shock test	Half sine ware shock acceleration: 20g Shock time: 11ms Six axes, one shock for each axial (\pm x, y and z)	TIA/EIA 603 3.3.5 GB/T15844.2 4.1
Temperature shock	Low temperature: -40°C \pm 2°C High temperature: +85°C \pm 2°C Changeover time: less than 30 seconds Test duration: 1 hour Repetition times: 100	IEC 68-2-14 Na ETS 300019-2-7
Damp heat cycling	High temperature: 55°C \pm 2°C Low temperature: +25°C \pm 2°C Humidity: 95% Repetition times: 4 Test duration: 12h+12h	IEC 68-2-30 Db
Low-temperature working	Temperature: -30 \pm 2°C Test duration: 48h	IEC 68-2-1 Ab
High-temperature working	Temperature: +70 \pm 2°C Test duration: 48h	IEC 68-2-2 Bb
Low-temperature storage	Temperature: -40 \pm 2°C Test duration: 24h	IEC 68-2-1 Ab
High-temperature storage	Temperature: +85 \pm 2°C Test duration: 24h	IEC 68-2-2 Bb

3.7 ESD

3.7.1 Overview

When using JT421E LTE module it is needed to pay attention to ESD (Electro – Static Discharge) for protection. According to the EN61000-4-2 standard, the performance of module ESD has been tested. And the test results are shown in table 3-7 below:

Table 3-7 JT421E LTE module ESD performance

Antenna interface	Air discharge: ± 8 k	V
	Contact discharge: ± 4 k	V
SIM card interface	Air discharge: ± 8 k	V
	Contact discharge: ± 4 k	V

3.7.2 USIM Card Interface ESD Protection

Recommended SIM card interface of the ESD protection circuit for JT421E LTE module is shown in figure 3-1. Among it, the TVS (transient voltage suppression diode) should be placed as near to SIM card slot as possible. Recommended SIM card slot interface circuit should be referred to figure 4-1.

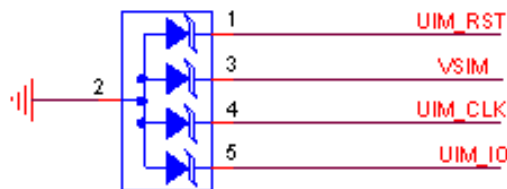

Figure 3-1 Recommended SIM card interface ESD protection circuit

4 Interface Applications

4.1 Overview

This chapter mainly describes each interface application of JT421E LTE module, including:

- USIM card interface
- Power interface
- USB bus
- LED status indication
- RESET interface

4.2 USIM Card Interface

A 3.0 V / 1.8 V USIM card can be connected to JT421E LTE module, with 3.0 V or 1.8 V interface level. The USIM card interface signals are shown in table 4-1.

Table 4-1 Definitions of USIM card interface pins

Index	PIN	PIN Description	Additional description
1	6	Reserved (SIM_DETECT)	Note 1
2	8	VSIM	USIM card power
3	14	UIM_RESET	USIM card reset signal
4	12	UIM_CLK	USIM card clock signal
5	10	UIM_DATA	USIM card data line
6	4/9/15/1 8 /21/26/2 7 /29/34/3 5 /37/40/4 3 /50	GND	Ground

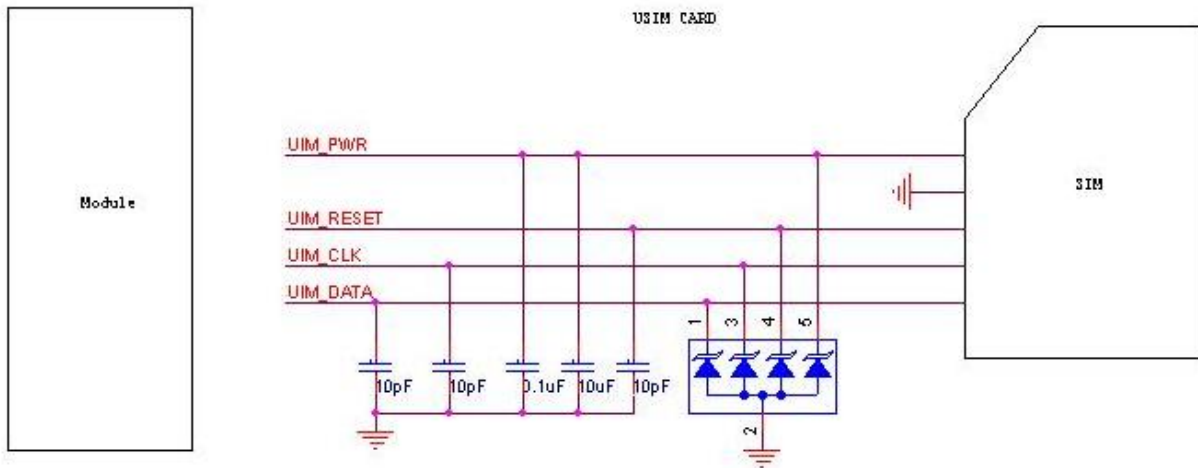

Figure 4-1 USIM card interface circuit schematic diagram

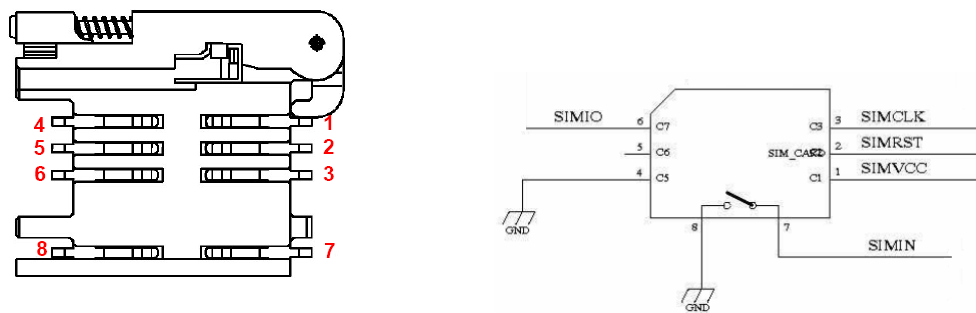

Figure 4-2 the order of USIM slot pins and connection diagram with USIM card

The SIM must support clock frequencies of 3.25 MHz. The SIM interface signals consist of four signals that are UIM_PWR, UIM_RST, UIM_CLK, and UIM_DATA (UIM_Vpp isn't connected also not used in many applications). Due to the relatively low clock frequencies involved, the concern is not the degradation of the SIM signals themselves. The main concern is routing of the SIM interface signals through areas considered to be of high risk for RF noise coupling (crosstalk and RF contamination) which can desensitize the radio circuitry.

- _ The general guidelines that should be followed are listed as follows:
- _ It is recommended that these signals should be routed over a contiguous ground plane.
- _ SIM interface signals should not be routed near high transient signals (power supply chokes and DC/DC switching FETs).
- _ Avoid routing of these signals near output connectors.
- _ Keep SIM interface signals isolated from other signals. 2x width spacing (1.5x min) between SIM interface signals and all other signal routing is recommended.

Since the SIM is a CMOS device, ESD protection devices should be placed near to the SIM

connector to provide protection before connecting to the module. In addition, all the SIM interface signals should be bypassed with a 10 pF capacitor.

4.3 Power Interface

Externally standard voltage from 3 V to 3.6 V (with the typical value of 3.3 V) is used as JT421E LTE module power supply. When the network signal is very weak, the antenna emission with maximum power will happen, with 1.2A of transient maximum current. So it is recommended to use LDO with more than 1.2A or switching power supply.

Besides considering the voltage drop when high-power launching, a large capacitance should be added to the module power supply port.

Note: Because EMC interference for switching power supply is rather big, the circuit line should not be close to the antenna part.

4.4 USB Bus

JT421E uses USB drive with VID of 0x2000 and PID of 0x258d. On the PC two ports can be mapped out, respectively:

1. 4G ACM port, carrying the AT command, it is mainly used for data traffic;
2. 4G ECM port, ECM standard card; Mainly for service information;

4.5 LED Status Indicators

2 pins of LED_WWAN provided by JT421E LTE module can be used as LED status indicators. The pin interface can be configured to programmable current source, to drive the outside indicators. The resistance can be adjusted to change the LED brightness.

4.6 RESET Interface

A PERST_N RESET pin provided by JT421E LTE module can hard RESET module through an external RESET circuit. Pull low RESET button (RESIN_N pin) to 100 ms, the module will be reset.

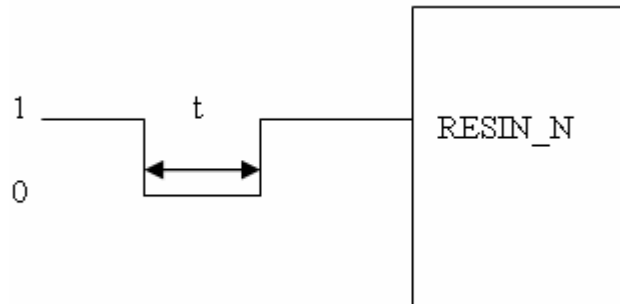

Figure 4-3: RESET interface

Note: $50\text{ ms} < t < 200\text{ ms}$. In addition, because the pin is rather sensitive to interference, it is important to pay attention to the module interface board line otherwise it may bring such as interference caused by module reset.

5 Mechanical Specifications

5.1 Overview

This chapter mainly describes mechanical specifications of JT421E LTE module, including:

- JT421E overall dimensions
- Mini PCI Express overall dimensions

5.2 JT421E Overall Dimensions

Size: 30 ± 0.20 x 50.95 ± 0.20 x 4.75 ± 0.10 mm

Weight: 12 ± 0.5 g

The overall dimensions are shown as Figure 5-1.

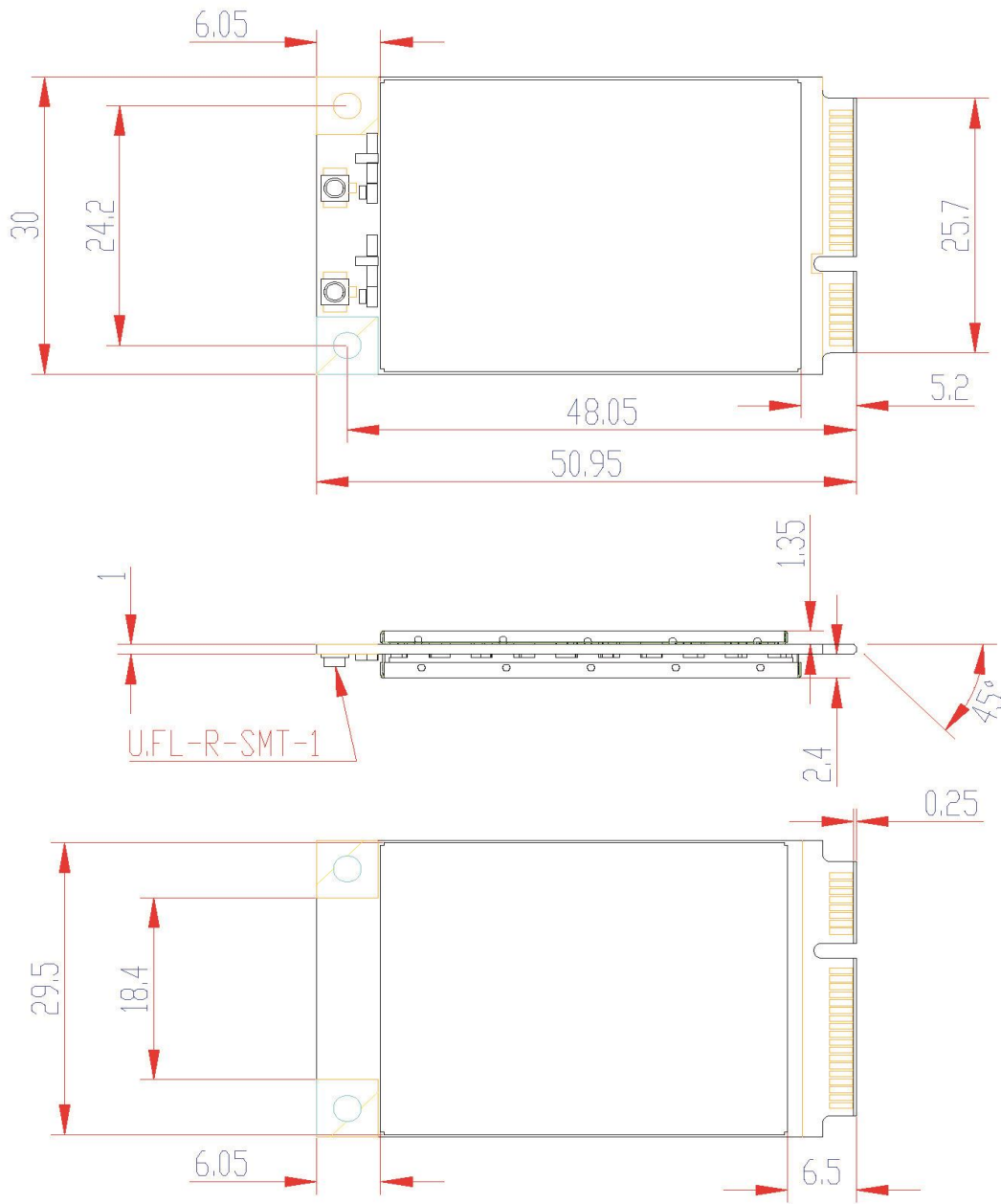

注释:

1. U.FL-R-SMT-1 建议搭配接头U.FL-LP(V)-040 配合高度2.0mm (max)

Figure 5-1 JT421E LTE module overall dimensions (Unit:mm)

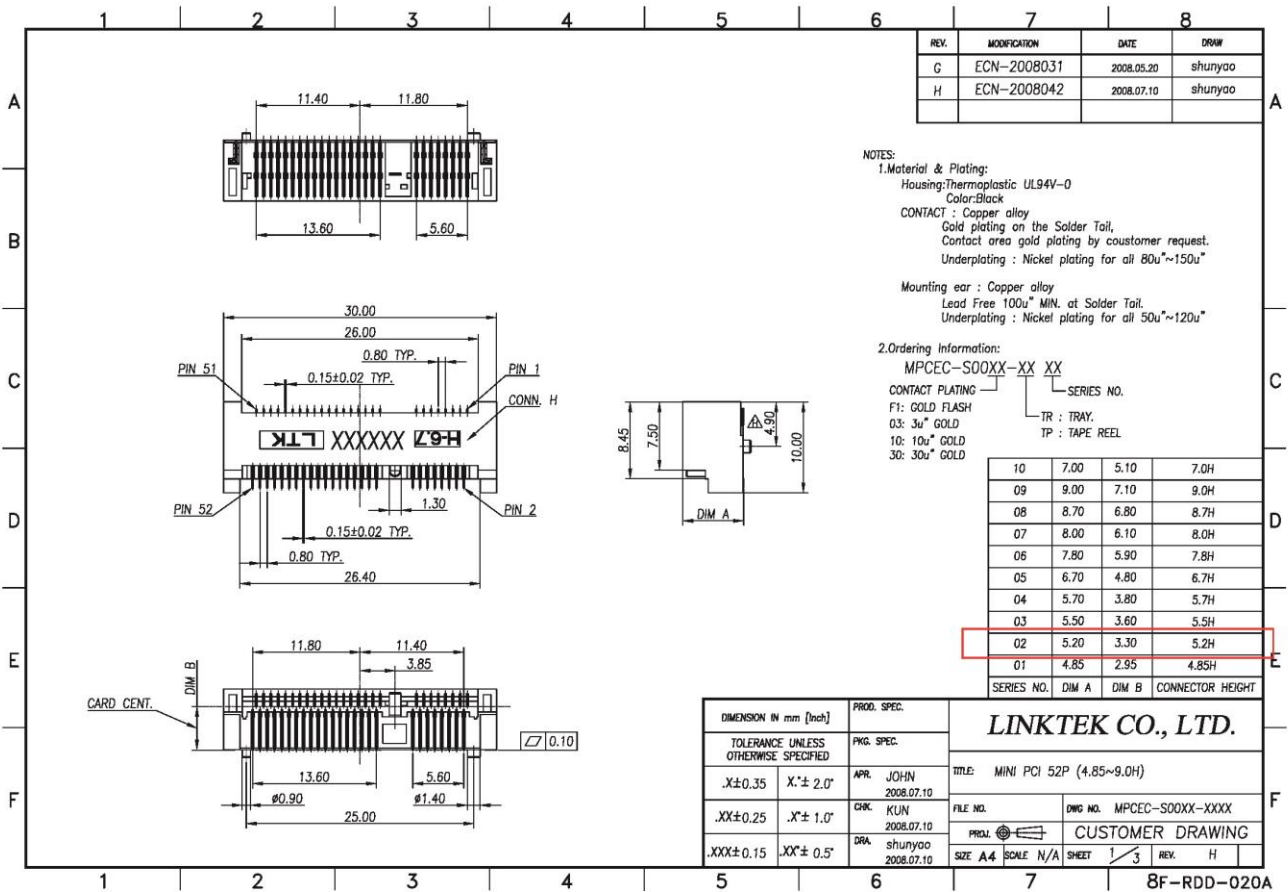

Figure 5-3 Mini PCI-E connector used on user board cooperating with JT421E LTE module